

# Banana Plug

25.431. \*

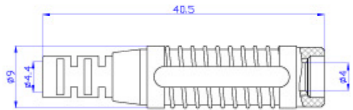

**Material**  
 Insulator:PA  
 Body:Brass  
 Surface:Nickel plated  
 \*Solder connection  
**Rated voltage/current**  
 30Vac-60Vdc/Max.24A



25.502. \*



**Material**  
 Insulator:PA  
 Body:Brass  
 Spring:Beryllium copper  
 Surface:Nickel plated  
 \*Solder connection  
**Rated voltage/current**  
 CATII 1000V/Max.32A

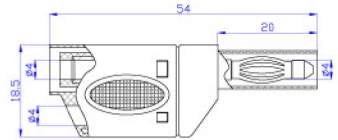

25.450. \*



**Material**  
 Insulator:PA  
 Body:Brass  
 Spring:Beryllium copper  
 Surface:Nickel plated  
 \*Solder connection  
**Rated voltage/current**  
 CATII 600V/Max.32A

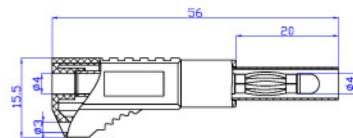

25.503. \*



**Material**  
 Insulator:PA  
 Body:Brass  
 Spring:Beryllium copper  
 Surface:Nickel plated  
 \*Solder connection  
**Rated voltage/current**  
 CATII 1000V/Max.32A

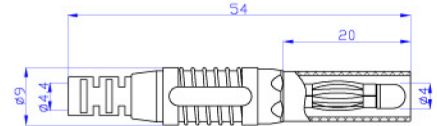

25.451. \*



**Material**  
 Insulator:PA  
 Body:Brass  
 Spring:Beryllium copper  
 Surface:Nickel plated  
 \*Press connection  
**Rated voltage/current**  
 30Vac-60Vdc/Max.32A

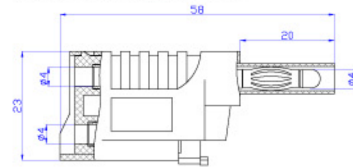

25.504. \*



**Material**  
 Insulator:PA  
 Body:Brass  
 Spring:Beryllium copper  
 Surface:Nickel plated  
 \*Solder connection  
**Rated voltage/current**  
 CATII 1000V/Max.32A

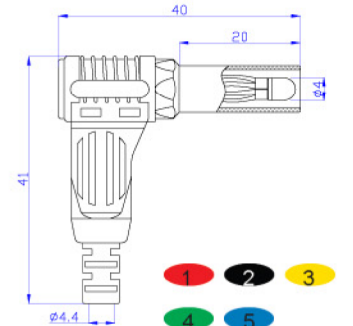
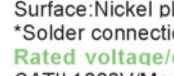

25.501. \*



**Material**  
 Insulator:PA  
 Body:Brass  
 Spring:Beryllium copper  
 Surface:Nickel plated  
 \*Solder connection  
**Rated voltage/current**  
 CATII 600V/Max.32A

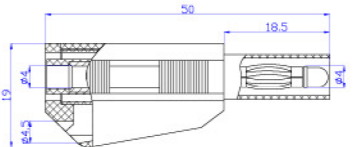

25.505. \*



**Material**  
 Insulator:PA  
 Body:Brass  
 Surface:Nickel plated  
 \*Solder connection  
**Rated voltage/current**  
 CATII 600V/Max.19A

